

SURGICAL GUIDE SLEEVES

Step Drill Sleeves / Pilot Drill Sleeves



FEATURES:

- Sleeve positioning by retentive fixture, no gluing necessary
- Easy and precise sleeve placement in the surgery guide by using the nt-insertion tool
- The optimized sleeve design also allows the use in narrow interdental spaces
- A drill mark on the sleeves upper edge facilitates the alignment when inserting into the surgery guide
- nt- trading drill sleeves are released in 3shape® Implant Studio for application



APPLICATION:

- For preparing the implant bed by using implant surgical drills
- Compatible to the appropriate implant surgery sets



TECHNICAL DETAILS:

- Titanium Grade 5 ELI

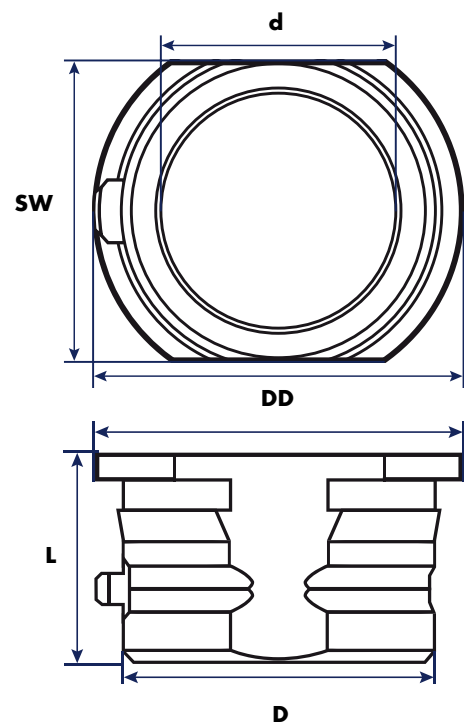

d = INNER DIAMETER | D = OUTER DIAMETER | DD = TREAD DIAMETER | L = LENGTH | SW = WIDTH











Notice: Products indicated with ® and ™ are registered brand names of the respective manufactures. Products indicated with * are available in the USA

SURGICAL GUIDE SLEEVES





Step Drill Sleeves / Pilot Drill Sleeves



SURGICAL GUIDE SLEEVES

	ART. NO.	SYSTEM	d	D	DD	L	SW	
	SGS 16.SD4.148	NobelBiocare™ NP	Ø 4,10 mm	4,80 mm	5,80 mm	4,00 mm	4,50 mm	★
	SGS 16.SD5.060	NobelBiocare™ RP	Ø 5,00 mm	6,00 mm	7,00 mm	4,00 mm	5,70 mm	★
	SGS 16.SD6.270	NobelBiocare™ WP	Ø 6,20 mm	7,00 mm	8,00 mm	4,00 mm	6,70 mm	★
	SGS 16.SD3.548	Camlog®	Ø 3,50 mm	4,80 mm	5,80 mm	3,00 mm	4,50 mm	★
	SGS 16.SD4.563	Camlog®	Ø 4,50 mm	6,00 mm	7,00 mm	3,00 mm	5,70 mm	★
	SGS 16.SD4.560	Ankylos®/Xive® ND	Ø 4,48 mm	6,00 mm	7,00 mm	4,00 mm	5,70 mm	★
	SGS 16.SD4.960	Ankylos® WD	Ø 4,90 mm	6,00 mm	7,00 mm	4,00 mm	5,70 mm	★
	SGS 16.SD5.260	Xive® WD	Ø 5,20 mm	6,00 mm	7,00 mm	4,00 mm	5,70 mm	★
	SGS 16.SD5.060	Straumann	Ø 5,00 mm	6,00 mm	7,00 mm	4,00 mm	5,70 mm	★
	SGS 16.SD4.760	Astra	Ø 4,70 mm	6,00 mm	7,00 mm	4,00 mm	5,70 mm	★
	SGS 16.SD5.770	Astra	Ø 5,70 mm	7,00 mm	8,00 mm	4,00 mm	6,70 mm	★

SINGLE SLEEVES

	ART. NO.	SYSTEM	d	D	DD	L	SW	
	SGS 16.PD2.032	Pilot drill-2,0 mm	2,00 mm	3,20 mm	4,20 mm	4,00 mm	2,90 mm	★
	SGS 16.PD2.232	Pilot drill-2,2 mm	2,20 mm	3,20 mm	4,20 mm	4,00 mm	2,90 mm	★
	SGS 16.PD2.332	Pilot drill-2,3 mm	2,35 mm	3,20 mm	4,20 mm	4,00 mm	2,90 mm	★
	SGS 16.PD2.848	Pilot drill-2,8 mm Straumann	2,80 mm	4,80 mm	5,80 mm	4,00 mm	4,50 mm	★

d = INNER DIAMETER | D = OUTER DIAMETER | DD = TREAD DIAMETER | L = LENGTH | SW = WIDTH

Notice: Products indicated with ® and ™ are registered brand names of the respective manufactures.
Products indicated with ★ are available in the USA 